

SHURE®

LEGENDARY
PERFORMANCE™

Axient® Digital Wireless Systems



AXIENT® DIGITAL WIRELESS SYSTEMS

Incorporating the most innovative wireless audio technology in the world, Axient Digital was engineered from the ground up for professional productions that demand flawless execution.

With an unprecedented level of signal stability and audio clarity, plus flexible hardware options, advanced connectivity, and comprehensive control, it's a wireless system built to take on the challenges of today—and tomorrow.

RF PROTECTION

With outstanding signal quality in even the most complex, congested environments, Axient Digital ensures maximum stability, range, and clarity for uncompromising audio—anywhere, every time.

AUDIO QUALITY

Axient Digital defies limitations for both RF and audio quality. With industry-leading low latency, transparent frequency response, and wide dynamic range, nothing gets in the way of true, pure sound. No matter the setting, it's Shure audio quality you can count on.

COMMAND & CONTROL

ShowLink® remote control, Wireless Workbench®, the ShurePlus™ Channels app, and networked battery monitoring provide unmatched control and insight, for seamless performance.

HARDWARE & SCALABILITY

With two transmitter series to choose from—both compatible with a shared receiver platform—Axient Digital is a scalable wireless system that provides incomparable sound for a wide range of applications and settings.

System Specifications

RF Carrier Range	470–960 MHz <i>Note: Varies by region (See Frequency Range and Output Power table)</i>
Working Range	100 m (330 ft) <i>Note: Actual range depends on RF signal absorption, reflection and interference.</i>
RF Tuning Step Size	25 kHz, varies by region
Image Rejection	>70 dB, typical
RF Sensitivity	–98 dBm at 10 ⁻⁵ BER
Latency	Standard mode: 2.0 ms High Density mode: 2.9 ms
Audio Frequency Response	AD1: 20 Hz – 20 kHz (±1 dB) AD2: 20 Hz – 20 kHz (±1 dB) ADX1: 20 Hz – 20 kHz (±1 dB) ADX1M: 20 Hz – 20 kHz (±1 dB) ADX2/ADX2FD: 20 Hz – 20 kHz (±1 dB) <i>Note: Dependent on microphone type</i>
Audio Dynamic Range <i>A-weighted, typical, System Gain @ +10</i>	XLR Analog Output: 120 dB (A-weighted); 117 (unweighted) Dante Digital Output: 130 dB (A-weighted); 126 (unweighted)
Total Harmonic Distortion <i>–6 dBFS input, 1 kHz, System Gain @ +10</i>	<0.01%
System Audio Polarity	Positive pressure on microphone diaphragm produces positive voltage on pin 2 (with respect to pin 3 of XLR output) and the tip of the 6.35 mm (1/4-inch) output.
Operating Temperature Range	–18 °C (0 °F) to 50 °C (122 °F) <i>Note: Battery characteristics may limit this range.</i>
Storage Temperature Range	–29 °C (–20 °F) to 65 °C (149 °F) <i>Note: Battery characteristics may limit this range.</i>

Furnished Accessories

Receivers

90XN1371	Hardware Kit
95A8994	BNC Bulkhead Adapter
Var. by region	½ Wave Receiver Antenna (2)
95B9023	BNC-BNC Cable (short)
95C9023	BNC-BNC Cable (long)
95N2035	Coaxial RF Cascade Cable
Var. by region	AC Power Cable, VLock
Var. by region	AC Power Jumper Cable
95A33402	Ethernet Cable, 3 ft.
95B33402	Ethernet Jumper Cable

Handheld Systems

95B2313	Zipper Bag
31B1856	Euro-threaded Adapter
90F4046	Swivel Adapter, black
80B8201	AA Alkaline Batteries (2)

Bodypack Systems

80B8201	AA Alkaline Batteries (2)
Var. by region	¼ Wave Antenna
WA340	Threaded T44F Adapter
WA610	Transmitter Carrying Case
26A13	Zipper Bag
44A12547	Belt Clip

Optional Accessories

Battery Chargers

SBRC	Rack-Mounted Networked Battery Charger
SBC-AX	SBRC Battery Charging Module for SB900A Batteries
SBM910	SBRC Battery Charging Module for SB910 Batteries
SBM910M	SBRC Battery Charging Module for SB910M Batteries
SBM920	SBRC Battery Charging Module for SB920 Batteries
SBC240	2-Bay Networked Docking Charger for ADX1, ADX2 & ADX2FD Transmitters, SB910 & SB920 Batteries
SBC840	8-Bay Networked Docking Charger for ADX1, ADX2 & ADX2FD Transmitters, SB910 & SB920 Batteries
SBC840M	8-Bay Networked Docking Charger for SB910M Batteries

Handheld Systems

WA617M	Radome Color ID Kit for AD2 Handheld Transmitter
WA619-A	Radome Color ID Kit for ADX Handheld Transmitter (470–636 MHz)
WA619-B	Radome Color ID Kit for ADX Handheld Transmitter (606–810 MHz)
WA619-C	Radome Color ID Kit for ADX Handheld Transmitter (750–960 MHz)
AD651B	Talk Switch Button (black)
WA371	Microphone stand adapter
SBC240	2-Bay Networked Docking Charger 2-Up

NOTE:

This Radio equipment is intended for use in musical professional entertainment and similar applications. This Radio apparatus may be capable of operating on some frequencies not authorized in your region. Please contact your national authority to obtain information on authorized frequencies and RF power levels for wireless microphone products.

Rechargeable Power Management

(sold separately, see individual product pages for specifications and compatibility information)

SB900A Lithium-Ion Rechargeable Battery

AD series transmitters are compatible with the SB900A lithium-ion rechargeable battery, which provides up to 9 hours of continuous use and precise tracking of remaining life and charge cycle details.

SB910 & SB920 Rechargeable Batteries

ADX1, ADX2 and ADX2FD ShowLink®-Enabled transmitters exclusively use SB910 or SB920 lithium-ion rechargeable batteries

SB910M Lithium-Ion Rechargeable Batteries

ADX1M micro bodypack transmitters exclusively use SB910M lithium-ion rechargeable batteries.

SBRC Networked Shure Battery Rack Charger

This tour-ready modular battery charging station charges a variety of Shure Li-Ion batteries, with support for up to eight SB900A, AXT910 and AXT920, all in a single rack-unit space. Wireless Workbench networkability and ShurePlus Channels compatibility provides convenient remote monitoring of charge status, and an easy-to-read front panel display that provides key battery charging and health metrics, including time-to-full, temperature and charge cycle count.

Battery Runtimes *(Note: Frequency Band Dependent)*

Battery Type	10 mW
SB900A	up to 9 hours
Alkaline	up to 8 hours
NiMH	up to 11 hours
Li-primary	up to 14 hours
SB910	up to 10 hours
SB910M	up to 7 hours
SB920	up to 9 hours up to 6.5 hours*

*ADX2FD in Frequency Diversity Mode

Updated: 04/19

www.shure.com

Whilst every effort has been made to ensure that the information in this document is correct, we accept no liability in respect of errors or omissions. All specifications within this document are subject to change without notice.

© 2019 Shure Incorporated

Component Specifications

AD4Q Four-Channel Wireless Receiver

Overview

The AD4Q Axient Digital Quad Receiver sets a new standard in transparent digital audio and maximum spectral efficiency. Groundbreaking performance features include wide tuning, low latency, High Density (HD) mode, and Quadversity™, ensuring solid performance in the most challenging RF environments. Networked control, AES3 + AES67 + Dante™ and signal routing options bring a new level of management and flexibility to your entire workflow. Compatible with all Axient Digital transmitters.

Features

- Wide tuning range up to 184MHz
- True digital diversity reception per channel for drop-out resistance
- Networked control with Wireless Workbench® and ShurePlus™ Channels app
- Quadversity™ mode for extended antenna coverage and improved RF signal-to-noise
- Front panel headphone jack enables Dante Cue and Dante Browse monitoring
- Configurable Ethernet switch for redundant Dante digital output
- Switchable XLR/AES3 outputs
- Channel Quality meter displays RF signal-to-noise
- Locking AC connectors
- Optional DC module available to support redundant power

Specifications

Dimensions	44 mm x 483 mm x 333 mm (1.7 in. x 19.0 in. x 13.1 in.), H x W x D
Weight	4.8 kg (10.6 lbs), without antennas
Housing	Steel; Extruded aluminum
Power Requirements	100 to 240 V AC, 50–60 Hz; 0.68 A max.
Thermal Dissipation	Maximum: 31 W (106 BTU/hr) Idle: 21 W (72 BTU/hr)

Audio Output

Gain Adjustment Range	–18 to +42 dB in 1 dB steps (plus Mute setting)
Configuration	1/4" (6.35 mm): Transformer-coupled Balanced (Tip=audio, Ring=no audio, Sleeve=ground) XLR: Transformer-coupled Balanced (1=ground, 2=audio +, 3=audio -)
Impedance <i>Typical, XLR Line out</i>	100Ω
Full Scale Output <i>200 kΩ load</i>	1/4" (6.35 mm): +8 dBV XLR: LINE setting= +18 dBV, MIC setting= –12 dBV
Mic/Line Switch	30 dB pad
Phantom Power Protection	Yes

Networking

Network Interface	10/100 Mbps, 1 Gbps, Dante Digital Audio
Network Addressing Capability	DHCP or Manual IP address
Maximum Ethernet Cable Length	100 m (328 ft)

Cascade output

Connector Type	BNC <i>Note: For connection of one additional receiver in the same band</i>
Configuration	Unbalanced, passive
Impedance	50 Ω
Insertion Loss	0 dB, typical

RF Input

Spurious Rejection	>80 dB, typical
Connector Type	BNC
Impedance	50 Ω
Bias Voltage	12–13.5 V DC, 150 mA maximum, per antenna, switchable on/off
RF Carrier Frequency Range <i>Model-dependent</i>	AD4Q=A: 470–636 MHz AD4Q=B: 606–810 MHz AD4Q=C: 750–960 MHz

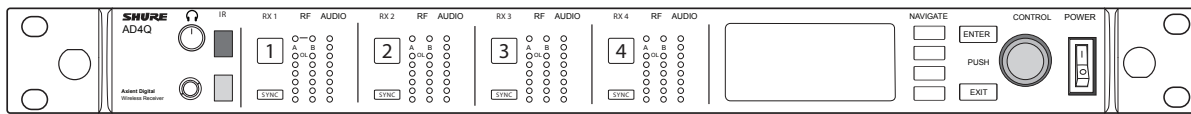

AD4Q
Quad-Channel Receiver
Front Panel

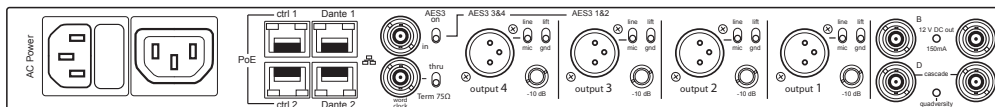

AD4Q
Quad-Channel Receiver
Rear Panel



Updated: 04/19

www.shure.com

Whilst every effort has been made to ensure that the information in this document is correct, we accept no liability in respect of errors or omissions. All specifications within this document are subject to change without notice.

© 2019 Shure Incorporated

Component Specifications

AD4D Two-Channel Wireless Receiver

Overview

The AD4D Axient Digital Dual Receiver sets a new standard in transparent digital audio and maximum spectral efficiency. Groundbreaking performance features include wide tuning, low latency, and High Density (HD) mode, ensuring solid performance in the most challenging RF environments. Networked control, AES3 + AES67 + Dante™ and signal routing options bring a new level of management and flexibility to your entire workflow. Compatible with all Axient Digital transmitters.

Features

- Wide tuning range up to 184MHz
- True digital diversity reception per channel for drop-out resistance
- Networked control with Wireless Workbench® and ShurePlus™ Channels app
- Front panel headphone jack enables Dante Cue and Dante Browse monitoring
- Configurable Ethernet switch for redundant Dante digital output
- AES3 output
- Channel Quality meter displays RF signal-to-noise
- Locking AC connectors

Specifications

Dimensions	44 mm × 483 mm × 333 mm (1.7 in. × 19.0 in. × 13.1 in.), H × W × D
Weight	4.6 kg (10.1 lbs), without antennas
Housing	Steel; Extruded aluminum
Power Requirements	100 to 240 V AC, 50–60 Hz; 0.26 A max.
Thermal Dissipation	Maximum: 23 W (78 BTU/hr) Idle: 15 W (52 BTU/hr)

Audio Output

Gain Adjustment Range	–18 to +42 dB in 1 dB steps (plus Mute setting)
Configuration	1/4" (6.35 mm): Transformer-coupled Balanced (Tip=audio, Ring=no audio, Sleeve=ground) XLR: Transformer-coupled Balanced (1=ground, 2=audio +, 3=audio -)
Impedance <i>Typical, XLR Line out</i>	100Ω
Full Scale Output <i>200 kΩ load</i>	1/4" (6.35 mm): +8 dBV XLR: LINE setting= +18 dBV, MIC setting= –12 dBV
Mic/Line Switch	30 dB pad
Phantom Power Protection	Yes

Networking

Network Interface	10/100 Mbps, 1 Gbps, Dante Digital Audio
Network Addressing Capability	DHCP or Manual IP address
Maximum Ethernet Cable Length	100 m (328 ft)

Cascade output

Connector Type	BNC <i>Note: For connection of one additional receiver in the same band</i>
Configuration	Unbalanced, passive
Impedance	50 Ω
Insertion Loss	0 dB, typical

RF Input

Spurious Rejection	>80 dB, typical
Connector Type	BNC
Impedance	50 Ω
Bias Voltage	12–13.5 V DC, 150 mA maximum, per antenna, switchable on/off
RF Carrier Frequency Range <i>Model-dependent</i>	AD4D=A: 470–636 MHz AD4D=B: 606–810 MHz AD4D=C: 750–960 MHz

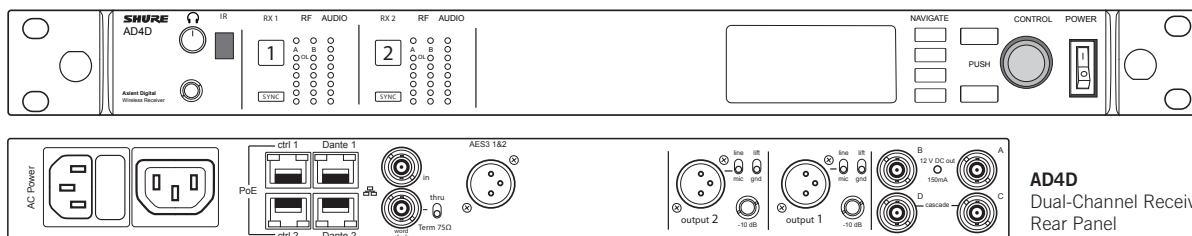

AD4D
Dual-Channel Receiver
Front Panel

AD4D
Dual-Channel Receiver
Rear Panel



Updated: 04/19

www.shure.com

Whilst every effort has been made to ensure that the information in this document is correct, we accept no liability in respect of errors or omissions. All specifications within this document are subject to change without notice.

© 2019 Shure Incorporated

Component Specifications

AD4Q-DC Four-Channel Wireless Receiver

Overview

The AD4Q Axient Digital Quad Receiver sets a new standard in transparent digital audio and maximum spectral efficiency. Groundbreaking performance features include wide tuning, low latency, High Density (HD) mode, and Quadversity™, ensuring solid performance in the most challenging RF environments. Networked control, AES3 + AES67 + Dante™ and signal routing options bring a new level of management and flexibility to your entire workflow. Compatible with all Axient Digital transmitters.

Features

- DC Power Module supports backup power sources and remote operation
- Wide tuning range up to 184MHz
- True digital diversity reception per channel for drop-out resistance
- Networked control with Wireless Workbench® and ShurePlus™ Channels app
- Quadversity™ mode for extended antenna coverage and improved RF signal-to-noise
- Front panel headphone jack enables Dante Cue and Dante Browse monitoring
- Configurable Ethernet switch for redundant Dante digital output
- Switchable XLR/AES3 outputs
- Channel Quality meter displays RF signal-to-noise
- Locking AC connectors

Specifications

Dimensions	44 mm × 483 mm × 333 mm (1.7 in. × 19.0 in. × 13.1 in.), H × W × D
Weight	4.8 kg (10.6 lbs), without antennas
Housing	Steel; Extruded aluminum
Power Requirements	100 to 240 V AC, 50–60 Hz; 0.68 A max.
Thermal Dissipation	Maximum: 31 W (106 BTU/hr) Idle: 21 W (72 BTU/hr)
DC Input Voltage Range	10.9–14.8 V DC
Maximum DC Input Current	AD4Q: 4.0 A
Protection Modes	Overvoltage, Undervoltage, Reverse Polarity
4-Pin XLR	Pin 1: Negative; Pin 2: No Connection; Pin 3: No Connection; Pin 4: Positive

Audio Output

Gain Adjustment Range	–18 to +42 dB in 1 dB steps (plus Mute setting)
Configuration	1/4" (6.35 mm): Transformer-coupled Balanced (Tip=audio, Ring=no audio, Sleeve=ground) XLR: Transformer-coupled Balanced (1=ground, 2=audio +, 3=audio -)
Impedance <i>Typical, XLR Line out</i>	100Ω
Full Scale Output <i>200 kΩ load</i>	1/4" (6.35 mm): +8 dBV XLR: LINE setting= +18 dBV, MIC setting= –12 dBV
Mic/Line Switch	30 dB pad
Phantom Power Protection	Yes

Networking

Network Interface	10/100 Mbps, 1 Gbps, Dante Digital Audio
Network Addressing Capability	DHCP or Manual IP address
Maximum Ethernet Cable Length	100 m (328 ft)

Cascade output

Connector Type	BNC <i>Note: For connection of one additional receiver in the same band</i>
Configuration	Unbalanced, passive
Impedance	50 Ω
Insertion Loss	0 dB, typical

RF Input

Spurious Rejection	>80 dB, typical
Connector Type	BNC
Impedance	50 Ω
Bias Voltage	12–13.5 V DC, 150 mA maximum, per antenna, switchable on/off
RF Carrier Frequency Range <i>Model-dependent</i>	AD4Q=A: 470–636 MHz AD4Q=B: 606–810 MHz AD4Q=C: 750–960 MHz

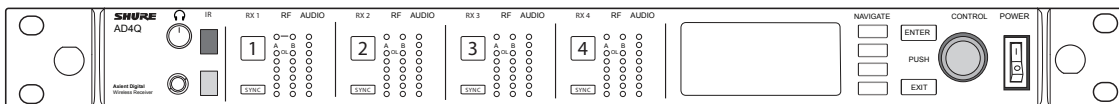

AD4Q-DC
Quad-Channel Receiver
Front Panel

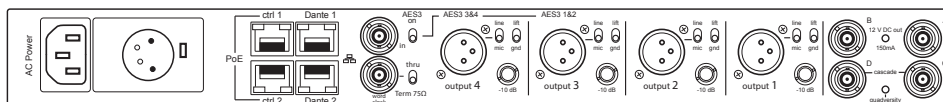

AD4Q-DC
Quad-Channel Receiver
Rear Panel



Updated: 04/19

www.shure.com

Whilst every effort has been made to ensure that the information in this document is correct, we accept no liability in respect of errors or omissions. All specifications within this document are subject to change without notice.

© 2019 Shure Incorporated

Component Specifications

AD4D-DC Two-Channel Wireless Receiver

Overview

The AD4D Axient Digital Dual Receiver sets a new standard in transparent digital audio and maximum spectral efficiency. Groundbreaking performance features include wide tuning, low latency, and High Density (HD) mode, ensuring solid performance in the most challenging RF environments. Networked control, AES3 + AES67 + Dante™ and signal routing options bring a new level of management and flexibility to your entire workflow. Compatible with all Axient Digital transmitters.

Features

- DC Power Module supports backup power sources and remote operation
- Wide tuning range up to 184MHz
- True digital diversity reception per channel for drop-out resistance
- Networked control with Wireless Workbench® and ShurePlus™ Channels app
- Front panel headphone jack enables Dante Cue and Dante Browse monitoring
- Configurable Ethernet switch for redundant Dante digital output
- AES3 output
- Channel Quality meter displays RF signal-to-noise
- Locking AC connectors

Specifications

Dimensions	44 mm × 483 mm × 333 mm (1.7 in. × 19.0 in. × 13.1 in.), H × W × D
Weight	4.6 kg (10.1 lbs), without antennas
Housing	Steel; Extruded aluminum
Power Requirements	100 to 240 V AC, 50–60 Hz; 0.26 A max.
Thermal Dissipation	Maximum: 23 W (78 BTU/hr) Idle: 15 W (52 BTU/hr)
DC Input Voltage Range	10.9–14.8 V DC
Maximum DC Input Current	AD4D: 3.3 A
Protection Modes	Overvoltage, Undervoltage, Reverse Polarity
4-Pin XLR	Pin 1: Negative; Pin 2: No Connection; Pin 3: No Connection; Pin 4: Positive

Audio Output

Gain Adjustment Range	–18 to +42 dB in 1 dB steps (plus Mute setting)
Configuration	1/4" (6.35 mm): Transformer-coupled Balanced (Tip=audio, Ring=no audio, Sleeve=ground) XLR: Transformer-coupled Balanced (1=ground, 2=audio +, 3=audio -)
Impedance <i>Typical, XLR Line out</i>	100Ω
Full Scale Output <i>200 kΩ load</i>	1/4" (6.35 mm): +8 dBV XLR: LINE setting= +18 dBV, MIC setting= –12 dBV
Mic/Line Switch	30 dB pad
Phantom Power Protection	Yes

Networking

Network Interface	10/100 Mbps, 1 Gbps, Dante Digital Audio
Network Addressing Capability	DHCP or Manual IP address
Maximum Ethernet Cable Length	100 m (328 ft)

Cascade output

Connector Type	BNC <i>Note: For connection of one additional receiver in the same band</i>
Configuration	Unbalanced, passive
Impedance	50 Ω
Insertion Loss	0 dB, typical

RF Input

Spurious Rejection	>80 dB, typical
Connector Type	BNC
Impedance	50 Ω
Bias Voltage	12–13.5 V DC, 150 mA maximum, per antenna, switchable on/off
RF Carrier Frequency Range <i>Model-dependent</i>	AD4D=A: 470–636 MHz AD4D=B: 606–810 MHz AD4D=C: 750–960 MHz



AD4D-DC
Dual-Channel
Receiver Front Panel

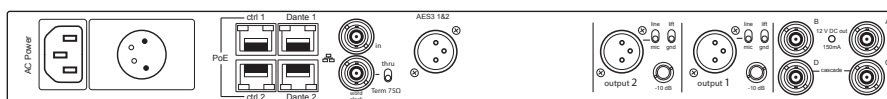

AD4D-DC
Dual-Channel
Receiver Rear Panel



Updated: 04/19

www.shure.com

Whilst every effort has been made to ensure that the information in this document is correct, we accept no liability in respect of errors or omissions. All specifications within this document are subject to change without notice.

© 2019 Shure Incorporated

Component Specifications

AD1 Bodypack Transmitter

Overview

AD series bodypack transmitters deliver impeccable audio quality and RF performance with wide-tuning, High Density (HD) mode, and encryption. Features durable metal construction, AA or SB900A rechargeable power (with dockable charging), and TA4 or LEMO3 connector options.

Features

- Two transmission modes:
 - Standard for optimal coverage
 - New High Density mode for maximum system channel count and robust coverage
- Encryption-enabled, secure transmission
- External contacts for docked charging
- AA or SB900A Li-ion rechargeable batteries
- Detachable ¼ wave antenna
- LEMO3 and TA4 connector options

Specifications

Gain Offset Range	-12 to 21 dB (in 1 dB steps)
Battery Type	Shure SB900A Rechargeable Li-Ion or LR6 AA batteries 1.5 V
Battery Runtime @ 10 mW	Shure SB900A: up to 9 hours Alkaline: up to 8 hours <i>See Battery Runtime Chart</i>
Dimensions	86 mm × 66 mm × 23 mm (3.4 in. × 2.6 in. × 0.9 in.) H × W × D
Weight	155 g (5.47 oz.), without batteries
Housing	Cast Aluminum

Audio Input

Connector	4-Pin male mini connector (TA4M)
<i>See drawing for details</i>	LEMO3 connector
Configuration	Unbalanced
Impedance	TA4M: 910 kΩ LEMO: 8.2 MΩ
<i>See drawing for details</i>	
Maximum Input Level <i>1 kHz at 1% THD</i>	Pad Off: 8.5 dBV (7.5 Vpp) Pad On: 20.5 dBV (30 Vpp)
Preamplifier Equivalent Input Noise (EIN) <i>System Gain Setting ≥ +20</i>	-120 dBV, A-weighted, typical

RF Output

Connector	SMA
Antenna Type	1/4 wave
Impedance	50 Ω
Occupied Bandwidth	<200 kHz
Modulation Type	Shure Axient Digital Proprietary
Power	2 mW, 10 mW, 35 mW <i>See Frequency Range and Output Power table, varies by region</i>

Available Models

AD1	Axient Digital Bodypack, TQG (TA4F) Connector
AD1LEMO3	Axient Digital Bodypack, LEMO3 Connector

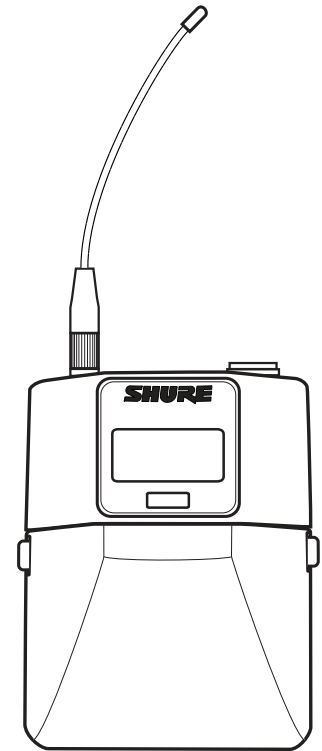

AD1
Bodypack Transmitter

Available Frequency Bands

Band	Range (MHz)	Transmitter Output (mW)
G53	470 to 510	2/10/35
G54	479 to 565	2/10/20
G55	470 to 636*	2/10/35
G56	470 to 636	2/10/35
G57	470 to 616*	2/10/35
G62	510 to 530	2/10/35
H54	520 to 636	2/10/35
K53	606 to 698*	2/10/35
K54	606 to 663**	2/10/35
K55	606 to 694	2/10/35
K56	606 to 714	2/10/35
K57	606 to 790	2/10/35
K58	622 to 698	2/10/35
L54	630 to 787	2/10/35
R52	794 to 806	2/10/35
JB	806 to 810	2/10
X51	925 to 937.5	2/10
X55	941 to 960	2/10/35

*Note: Not all frequencies available in all regions. Contact your authorized Shure dealer for availability.
* with a gap between 608 to 614 MHz
** with a gap between 608 to 614 MHz and a gap between 616 to 653 MHz*



Component Specifications

AD2 Handheld Transmitter

Overview

AD series hand-held transmitters deliver impeccable audio quality and RF performance with wide-tuning, High Density (HD) mode, and encryption. Features durable metal construction, AA or SB900A rechargeable power (with dockable charging), and black or nickel finish options.

Features

- Two transmission modes:
 - Standard for optimal coverage
 - New High Density mode for maximum system channel count and robust coverage
- Encryption-enabled, secure transmission
- Frequency and power lockout
- Rugged metal construction in black or nickel finish
- External contacts for docked charging
- AA or SB900A Li-ion rechargeable batteries
- Backlit LCD with easy-to-navigate menu and controls
- Low-profile, lockable power switch
- Available cartridges: KSM8, KSM9HS, Beta® 87A/87C, Beta® 58, SM58®, VP68

Specifications

Mic Offset Range	-12 to 21 dB (in 3 dB steps)
Battery Type	Shure SB900A Rechargeable Li-Ion or LR6 AA batteries 1.5 V
Battery Runtime @ 10 mW	Shure SB900A: up to 9 hours Alkaline: 8 hours <i>See Battery Runtime Chart</i>
Dimensions	256 mm x 51 mm (10.1 in. x 2.0 in.) L x D
Weight	340 g (12.0 oz.), without batteries
Housing	Cast aluminum

Audio Input

Configuration	Unbalanced
Maximum Input Level <i>1 kHz at 1% THD.</i>	145 dB SPL, typical (SM58) <i>Note: dependent on microphone type</i>

RF Output

Antenna Type	Integrated Single-Band Helical
Occupied Bandwidth	<200 kHz
Modulation Type	Shure Axient Digital Proprietary
Power	2 mW, 10 mW, 35 mW <i>See Frequency Range and Output Power table, varies by region</i>

Available Models

AD2	Axient Digital Handheld Transmitter
AD2/B58A	...with Beta® 58A Supercardioid Dynamic Vocal Wireless Microphone Capsule
AD2/B87A	...with Beta® 87A Supercardioid Condenser Vocal Wireless Microphone Capsule
AD2/B87C	...with Beta® 87C Cardioid Condenser Vocal Wireless Microphone Capsule
AD2/K8N	...with KSM8 Dualdyne™ Cardioid Dynamic Wireless Microphone Capsule (Nickel)
AD2/K8B	...with KSM8 Dualdyne™ Cardioid Dynamic Wireless Microphone Capsule (Black)
AD2/K9N	...with KSM9 Dual-Pattern Condenser Wireless Microphone Capsule (Nickel)
AD2/K9HSN	...with KSM9HS Multi-Pattern Dual Diaphragm Condenser Wireless Microphone Capsule (Nickel)
AD2/K9B	...with KSM9 Dual-Pattern Condenser Wireless Microphone Capsule (Black)
AD2/K9HSB	...with KSM9HS Multi-Pattern Dual Diaphragm Condenser Wireless Microphone Capsule (Black)
AD2/SM58	...with SM58® Cardioid Dynamic Vocal Wireless Microphone Capsule
AD2/VP68	...with VP68 Omnidirectional Condenser Wireless Microphone Capsule

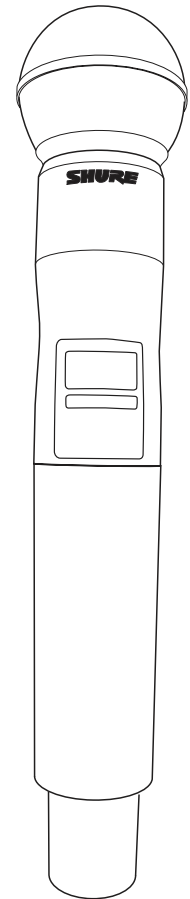

AD2
Handheld Transmitter

Available Frequency Bands

Band	Range (MHz)	Transmitter Output (mW)
G53	470 to 510	2/10/35
G54	479 to 565	2/10/20
G55	470 to 636*	2/10/35
G56	470 to 636	2/10/35
G57	470 to 616*	2/10/35
G62	510 to 530	2/10/35
H54	520 to 636	2/10/35
K53	606 to 698*	2/10/35
K54	606 to 663**	2/10/35
K55	606 to 694	2/10/35
K56	606 to 714	2/10/35
K57	606 to 790	2/10/35
K58	622 to 698	2/10/35
L54	630 to 787	2/10/35
R52	794 to 806	2/10/35
JB	806 to 810	2/10
X51	925 to 937.5	2/10
X55	941 to 960	2/10/35

*Note: Not all frequencies available in all regions. Contact your authorized Shure dealer for availability.
* with a gap between 608 to 614 MHz
** with a gap between 608 to 614 MHz and a gap between 616 to 653 MHz*



Component Specifications

ADX1M Micro Bodypack Transmitter

Overview

ADX1M delivers impeccable audio quality and RF performance, and is equipped with ShowLink® remote control for real-time parameter adjustments and interference avoidance. The contoured form factor and lightweight PEI construction offer both comfort and heat resistance. This transmitter features wide tuning, High Density (HD) mode, encryption, and advanced rechargeability. Membrane switches and LEMO connector protect against moisture, while the OLED display provides excellent visibility in low-light environments.

Features

- Small and streamlined design for better concealment and wear (68mm × 60mm × 18mm)
- High-contrast OLED display
- Diversity ShowLink enabled for remote transmitter control and automatic interference avoidance
- Patent-pending internal adaptive antenna for optimized signal when ADX1M is worn against the body
- Ultem® PEI construction for heat resistance and durability
- Recessed LEMO connector
- Sealed buttons and LEMO connection for protection against sweat and moisture ingress*
- Two transmission modes: Standard for optimal coverage and new High Density for maximum system channel count and robust coverage
- Encryption-enabled, secure transmission
- Up to 7 hours of runtime with SB910M rechargeable batteries
- Detachable belt clip

Specifications

Gain Offset Range	-12 to 21 dB (in 1 dB steps)
Battery Type	Shure SB910M Rechargeable Li-Ion
Battery Runtime @ 10 mW	SB910M: up to 7 hours†
Dimensions	60.4 mm × 68.0 mm × 22.1 mm (2.4 in. × 2.7 in. × 0.9 in.) H × W × D
Weight	Weight 53 g (1.9 oz.), without battery
Housing	Ultem® (PEI)

Audio Input

Connector	LEMO3 connector
See drawing for details	
Configuration	Unbalanced
Impedance	8.2 MΩ
See drawing for details	
Maximum Input Level 1 kHz at 1% THD	Pad Off: 8.5 dBV (7.5 Vpp) Pad On: 20.5 dBV (30 Vpp)
Preamp Equivalent Input Noise (EIN) System Gain Setting ≥ +20	-120 dBV, A-weighted, typical

RF Output

Antenna Type	Integrated Helical
Impedance	50 Ω
Occupied Bandwidth	<200 kHz
Modulation Type	Shure Axient Digital Proprietary
Power	2 mW, 10 mW, 20 mW <i>Varies by Region; See Available Frequency Bands and Output Power table.</i>

ShowLink®

Network Type	IEEE 802.15.4
Antenna Type	ZigBee Dual Conformal
Frequency Range	2.40 to 2.4835 GHz (24 Channels)
RF Output Power <i>Varies by Region</i>	10 dBm (ERP)

Available Models

ADX1M	Axient Digital Micro Bodypack Transmitter, LEMO3 Connector
-------	--

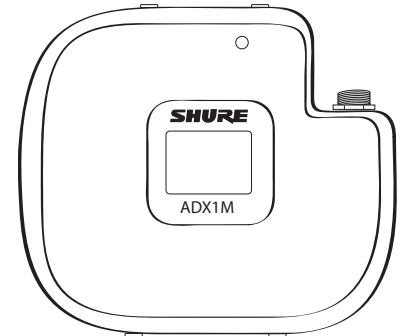

ADX1M
Micro Bodypack
Transmitter

Available Frequency Bands

Band	Range (MHz)	Transmitter Output (mW)
G53	470 to 510	2/10/20
G54	479 to 565	2/10/20
G55	470 to 636*	2/10/20
G56	470 to 636	2/10/20
G57	470 to 616*	2/10/20
G62	510 to 530	2/10/20
H54	520 to 636	2/10/20
K53	606 to 698*	2/10/20
K54	606 to 663**	2/10/20
K55	606 to 694	2/10/20
K56	606 to 714	2/10/20
K57	606 to 790	2/10/20
K58	622 to 698	2/10/20
L54	630 to 787	2/10/20
R52	794 to 806	2/10/20
JB	806 to 810	2/10/20
X51	925 to 937.5	2/10
X55	941 to 960	2/10/20

*Note: Not all frequencies available in all regions. Contact your authorized Shure dealer for availability.
* with a gap between 608 to 614 MHz
** with a gap between 608 to 614 MHz and a gap between 616 to 653 MHz*



Component Specifications

ADX1 ShowLink®-Enabled Bodypack Transmitter

Overview

ADX1, like all ADX transmitters, sets the stage for exceptional performance, with wide tuning up to 184 MHz, interference protection, advanced rechargeability, streamlined design, and ShowLink® remote control for real-time parameter adjustments right from the booth.

Features

- Removable antenna and fully concealed buttons and switch
- Two connector options: TA4 and LEMO3
- Advanced control menu with powerful features
- Durable, moisture-resistant,* lightweight metal case
- Up to 10 hours of runtime with SB910 rechargeable batteries
- Diversity ShowLink enabled for remote transmitter control and automatic interference avoidance
- External contacts for docked charging
- Two transmission modes: Standard for optimal coverage and new High Density for maximum system channel count and robust coverage
- Encryption-enabled, secure transmission

Specifications

Gain Offset Range	-12 to 21 dB (in 1 dB steps)
Battery Type	Shure SB910 Rechargeable Li-Ion
Battery Runtime @ 10 mW	SB910: up to 10 hours†
Dimensions	91 mm × 68 mm × 19 mm (3.6 in. × 2.7 in. × 0.8 in.) H × W × D
Weight	142g (5.0 oz.), without battery
Housing	Aluminum

Audio Input

Connector	4-pin Male Mini TQG (TA4M) Connector
<i>See drawing for details</i>	LEMO3 connector
Configuration	Unbalanced
Impedance	TA4M: 1 MΩ
<i>See drawing for details</i>	LEMO: 8.2 MΩ
Maximum Input Level	Pad Off: 8.5 dBV (7.5 Vpp)
1 kHz at 1% THD	Pad On: 20.5 dBV (30 Vpp)
Preamp Input Equivalent Input Noise (EIN)	-120 dBV, A-weighted, typical
<i>System Gain Setting ≥ +20</i>	

RF Output

Connector	SMA
Antenna Type	UHF ¼ Wave
Impedance	50 Ω
Occupied Bandwidth	<200 kHz
Modulation Type	Shure Axient Digital Proprietary
Power	2 mW, 10 mW, 20 mW, 40mW
	<i>Varies by Region; See Available Frequency Bands and Output Power table.</i>

ShowLink®

Network Type	IEEE 802.15.4
Antenna Type	ZigBee Dual Conformal
Frequency Range	2.40 to 2.4835 GHz (24 Channels)
RF Output Power	10 dBm (ERP)
<i>Varies by Region</i>	

Available Models

ADX1	Axient Digital ShowLink®-Enabled Bodypack Transmitter, TA4M Connector
ADX1LEMO3	Axient Digital ShowLink®-Enabled Bodypack Transmitter, LEMO3 Connector

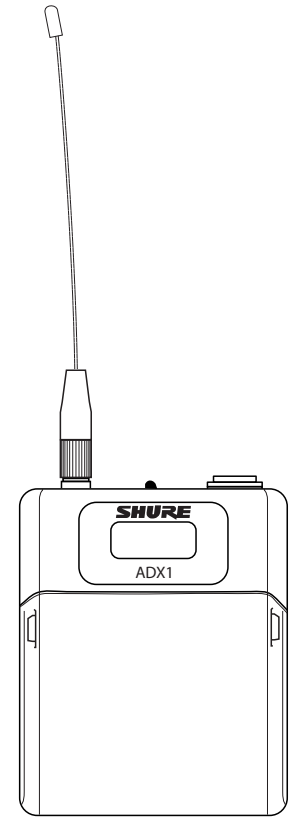

ADX1
ShowLink®-Enabled
Bodypack Transmitter

Available Frequency Bands

Band	Range (MHz)	Transmitter Output (mW)
G53	470 to 510	2/10/40
G54	479 to 565	2/10/20
G55	470 to 636*	2/10/40
G56	470 to 636	2/10/40
G57	470 to 616*	2/10/40
G62	510 to 530	2/10/40
H54	520 to 636	2/10/40
K53	606 to 698*	2/10/40
K54	606 to 663**	2/10/40
K55	606 to 694	2/10/40
K56	606 to 714	2/10/40
K57	606 to 790	2/10/40
K58	622 to 698	2/10/40
L54	630 to 787	2/10/40
R52	794 to 806	2/10/40
JB	806 to 810	2/10/40
X51	925 to 937.5	2/10
X55	941 to 960	2/10/40

*Note: Not all frequencies available in all regions. Contact your authorized Shure dealer for availability.
* with a gap between 608 to 614 MHz
** with a gap between 608 to 614 MHz and a gap between 616 to 653 MHz*

SHURE®

www.shure.com

Updated: 04/19

Whilst every effort has been made to ensure that the information in this document is correct, we accept no liability in respect of errors or omissions. All specifications within this document are subject to change without notice.

© 2019 Shure Incorporated

Component Specifications

ADX2 ShowLink®-Enabled Handheld Transmitter

Overview

ADX2, like all ADX transmitters, sets the stage for exceptional performance, with wide tuning up to 184 MHz, interference protection, advanced rechargeability, streamlined design, and ShowLink remote control for real-time parameter adjustments right from the booth.

Features

- Durable, moisture-resistant, lightweight metal case
- Available in black or nickel finish
- Up to 9 hours of runtime with SB920 rechargeable batteries
- External contacts for docked charging with optional fully covered radome
- Diversity ShowLink enabled for remote transmitter control and automatic interference avoidance
- Two transmission modes: Standard for optimal coverage and new High Density for maximum system channel count and robust coverage
- Encryption-enabled, secure transmission

Specifications

Mic Offset Range	-12 to 21 dB (in 3 dB steps)
Battery Type	Shure SB920 Rechargeable Li-Ion
Battery Runtime @ 10 mW	Shure SB920: Up to 9 hours
Dimensions	254 mm x 51 mm (10.0 in. x 2.0 in.) L x Dia.
Weight	338 g (11.9 oz.), without battery
Housing	Cast Aluminum

Audio Input

Configuration	Unbalanced
Maximum Input Level 1 kHz at 1% THD,	145 dB SPL, typical (SM58) <i>Note: dependent on microphone type</i>

RF Output

Antenna Type	Dual-Band Helical
Occupied Bandwidth	<200 kHz
Modulation Type	Shure Axient Digital Proprietary
Power	2 mW, 10 mW, 20 mW, 40mW <i>Varies by Region; See Available Frequency Bands and Output Power table.</i>

ShowLink®

Network Type	IEEE 802.15.4
Antenna Type	ZigBee Dual Conformal
Frequency Range	2.40 to 2.4835 GHz (24 Channels)
RF Output Power <i>Varies by Region</i>	10 dBm (ERP)

Available Models

ADX2	Axient Digital ShowLink®-Enabled Handheld Transmitter
ADX2/B58A	...with Beta® 58A Supercardioid Dynamic Vocal Wireless Microphone Capsule
ADX2/B87A	...with Beta® 87A Supercardioid Condenser Vocal Wireless Microphone Capsule
ADX2/B87C	...with Beta® 87C Cardioid Condenser Vocal Wireless Microphone Capsule
ADX2/K8N	...with KSM8 Dualdyne™ Cardioid Dynamic Wireless Microphone Capsule (Nickel)
ADX2/K8B	...with KSM8 Dualdyne™ Cardioid Dynamic Wireless Microphone Capsule (Black)
ADX2/K9N	...with KSM9 Dual-Pattern Condenser Wireless Microphone Capsule (Nickel)
ADX2/K9HSN	...with KSM9HS Multi-Pattern Dual Diaphragm Condenser Wireless Microphone Capsule (Nickel)
ADX2/K9B	...with KSM9 Dual-Pattern Condenser Wireless Microphone Capsule (Black)
ADX2/K9HSB	...with KSM9HS Multi-Pattern Dual Diaphragm Condenser Wireless Microphone Capsule (Black)
ADX2/SM58	...with SM58® Cardioid Dynamic Vocal Wireless Microphone Capsule
ADX2/VP68	...with VP68 Omnidirectional Condenser Wireless Microphone Capsule

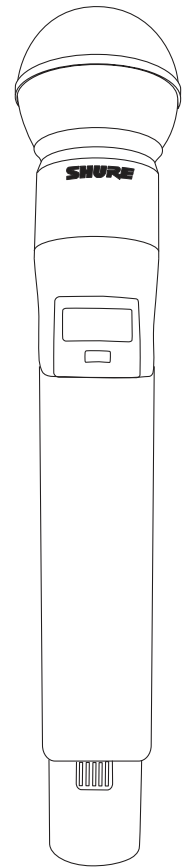

ADX2
ShowLink®-Enabled
Handheld Transmitter

Available Frequency Bands

Band	Range (MHz)	Transmitter Output (mW)
G53	470 to 510	2/10/40
G54	479 to 565	2/10/20
G55	470 to 636*	2/10/40
G56	470 to 636	2/10/40
G57	470 to 616*	2/10/40
G62	510 to 530	2/10/40
H54	520 to 636	2/10/40
K53	606 to 698*	2/10/40
K54	606 to 663**	2/10/40
K55	606 to 694	2/10/40
K56	606 to 714	2/10/40
K57	606 to 790	2/10/40
K58	622 to 698	2/10/40
L54	630 to 787	2/10/40
R52	794 to 806	2/10/40
JB	806 to 810	2/10
X51	925 to 937.5	2/10
X55	941 to 960	2/10/40

*Note: Not all frequencies available in all regions. Contact your authorized Shure dealer for availability.
* with a gap between 608 to 614 MHz
** with a gap between 608 to 614 MHz and a gap between 616 to 653 MHz*

SHURE®

Updated: 04/19

www.shure.com

Whilst every effort has been made to ensure that the information in this document is correct, we accept no liability in respect of errors or omissions. All specifications within this document are subject to change without notice.

© 2019 Shure Incorporated

Component Specifications

ADX2FD ShowLink®-Enabled Frequency Diversity Handheld Transmitter

Overview

ADX2FD, like all ADX transmitters, sets the stage for exceptional performance, with wide tuning up to 184 MHz, interference protection, advanced rechargeability, streamlined design, and ShowLink remote control for real-time parameter adjustments right from the booth.

Features

- Ability to transmit RF signal on two discrete carriers
- Optional 50mW High Power mode for driving increased power on a single frequency
- Durable, moisture-resistant, lightweight metal case
- Available in black or nickel finish
- Up to 6.5 hours of runtime with SB920 rechargeable batteries when transmitting on two RF carriers, up to 9 hours battery life when transmitting on a single RF carrier.
- External contacts for docked charging with optional fully covered radome
- Diversity ShowLink enabled for remote transmitter control and automatic interference avoidance
- Two transmission modes: Standard for optimal coverage and new High Density for maximum system channel count and robust coverage
- Encryption-enabled, secure transmission

Specifications

Mic Offset Range	-12 to 21 dB (in 3 dB steps)
Battery Type	Shure SB920 Rechargeable Li-Ion
Battery Runtime @ 10 mW	Single Carrier Mode: Up to 9 hours Frequency Diversity: Up to 6.5 hours
Weight	254 mm x 51 mm (10.0 in. x 2.0 in.) L x Dia. 338 g (11.9 oz.), without battery
Housing	Cast Aluminum
Audio Input	
Configuration	Unbalanced
Maximum Input Level 1 kHz at 1% THD.	145 dB SPL, typical (SM58) <i>Note: dependent on microphone type</i>
RF Output	
Antenna Type	Integrated Dual-Band Helical
Occupied Bandwidth	<200 kHz
Channel-to-Channel Spacing	Standard Mode: 350 kHz High-Density Mode: 125 kHz
Modulation Type	Shure Axient Digital Proprietary
Power	Single Carrier Mode: 2 mW, 10 mW, 20 mW, 50 mW Frequency Diversity Mode: 2 x 20 mW <i>Varies by Region; See Available Frequency Bands and Output Power table.</i>
ShowLink®	
Network Type	IEEE 802.15.4
Antenna Type	ZigBee Dual Conformal
Frequency Range	2.40 to 2.4835 GHz (24 Channels)
RF Output Power <i>Varies by Region</i>	10 dBm (ERP)

Available Models

ADX2FD	Axient Digital ShowLink®-Enabled Frequency Diversity Handheld Transmitter
ADX2FD/B58A	...with Beta® 58A Supercardioid Dynamic Vocal Wireless Microphone Capsule
ADX2FD/B87A	...with Beta® 87A Supercardioid Condenser Vocal Wireless Microphone Capsule
ADX2FD/B87C	...with Beta® 87C Cardioid Condenser Vocal Wireless Microphone Capsule
ADX2FD/K8N	...with KSM8 Duality™ Cardioid Dynamic Wireless Microphone Capsule (Nickel)
ADX2FD/K8B	...with KSM8 Duality™ Cardioid Dynamic Wireless Microphone Capsule (Black)
ADX2FD/K9N	...with KSM9 Dual-Pattern Condenser Wireless Microphone Capsule (Nickel)
ADX2FD/K9HSN	...with KSM9HS Multi-Pattern Dual Diaphragm Condenser Wireless Microphone Capsule (Nickel)
ADX2FD/K9B	...with KSM9 Dual-Pattern Condenser Wireless Microphone Capsule (Black)
ADX2FD/K9HSB	...with KSM9HS Multi-Pattern Dual Diaphragm Condenser Wireless Microphone Capsule (Black)
ADX2FD/SM58	...with SM58® Cardioid Dynamic Vocal Wireless Microphone Capsule
ADX2FD/VP68	...with VP68 Omnidirectional Condenser Wireless Microphone Capsule

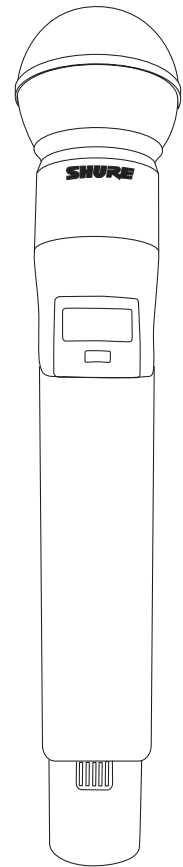

ADX2FD
Frequency Diversity
Handheld Transmitter

Available Frequency Bands

Band	Range (MHz)	Transmitter Output (mW)	
		Single Carrier	Frequency Diversity
G53	470 to 510	2/10/50	2/10/20
G54	479 to 565	2/10/20	2/10/20
G55	470 to 636*	2/10/50	2/10/20
G56	470 to 636	2/10/50	2/10/20
G57	470 to 616*	2/10/50	2/10/20
G62	510 to 530	2/10/50	2/10/20
H54	520 to 636	2/10/50	2/10/20
K53	606 to 698*	2/10/50	2/10/20
K54	606 to 663**		N/A
K55	606 to 694	2/10/50	2/10/20
K56	606 to 714	2/10/50	2/10/20
K57	606 to 790	2/10/50	2/10/20
K58	622 to 698	2/10/50	2/10/20
L54	630 to 787	2/10/50	2/10/20
R52	794 to 806	2/10/50	2/10/20
JB	806 to 810		N/A
X51	925 to 937.5	2/10	2/10/20
X55	941 to 960	2/10/50	2/10/35

*Note: Not all frequencies available in all regions. Contact your authorized Shure dealer for availability.
* with a gap between 608 to 614 MHz
** with a gap between 608 to 614 MHz and a gap between 616 to 653 MHz*



Updated: 04/19

www.shure.com

Whilst every effort has been made to ensure that the information in this document is correct, we accept no liability in respect of errors or omissions. All specifications within this document are subject to change without notice.

© 2019 Shure Incorporated

Component Specifications

AXT600 Spectrum Manager

Overview

The Axient Spectrum Manager is a powerful tool for calculating, analyzing and assigning compatible frequencies to wireless components. The Spectrum Manager scans the RF environment and uses this data to calculate compatible frequencies for all wireless channels found on the network. Networked wireless systems can be programmed from the Compatible Frequency List, while backup frequencies are continuously monitored and ranked according to quality. During operation, the Spectrum Manager deploys clear frequencies to receivers when interference occurs. Built-in spectrum monitoring tools provide visual and audio tracking of RF activity.

Features

- The Spectrum Manager captures scan data for the entire UHF frequency range available for wireless audio
- The on-board frequency calculator can be adjusted to avoid specific TV channels, frequency ranges or RF signal above a specified threshold
- Event Log records actions of the Spectrum Manager during operation and provides a snapshot of system performance.
- Backup Frequency Monitoring
- The data screen tracks the real-time status of in-use and backup frequencies
- Scanner feature graphically plots the measured RF signal across the full frequency range
- Use the Listen feature to tune to a frequency and monitor FM demodulated signal using headphones
- Networking enables many of the advanced features of the Axient system, including monitoring and control of remote devices
- RF Cascade Ports allow sharing of RF signal with up to 5 components without antenna splitters or distribution amplifiers

Specifications

RF Tuning Frequency Range	470-865, 925-952 MHz								
RF Tuning Step Size	25, 200, 1000 kHz								
Scan Time	The Spectrum Manager scans the entire RF tuning frequency range in 64 seconds using 8 scanning modules in parallel. Scan time per 60 MHz may be less for specified ranges that allow scanning modules to work in parallel. <table><thead><tr><th>Step Size</th><th>Maximum Scan Time per 60 MHz</th></tr></thead><tbody><tr><td>25 kHz:</td><td>48 seconds</td></tr><tr><td>*200 kHz:</td><td>7 seconds</td></tr><tr><td>*1000 kHz:</td><td>1 second</td></tr></tbody></table> *Available only with WWB6 control	Step Size	Maximum Scan Time per 60 MHz	25 kHz:	48 seconds	*200 kHz:	7 seconds	*1000 kHz:	1 second
Step Size	Maximum Scan Time per 60 MHz								
25 kHz:	48 seconds								
*200 kHz:	7 seconds								
*1000 kHz:	1 second								
Noise Floor	Resolution Bandwidth 25 kHz: -110 dBm 200 kHz: -100 dBm 1000 kHz: -90 dBm								
Image Rejection	>110 dB, typical								
Spurious Response	<-100 dBm, typical								
Ultimate Quieting	>90 dB, A-Weighted								
Dimensions	44 mm x 483 mm x 366 mm (1.7 in. x 19.0 in. x 14.4 in.), H x W x D								
Weight	5.5 kg (12.0 lbs)								
Housing	Steel; Extruded aluminum								
Power Requirements	100 to 240 V AC, 50-60 Hz								
Current Drain	0.8 A RMS (referenced at 120 V AC)								
Operating Temperature Range	-18°C (0°F) to 63°C (145°F)								
RF Input									
Connector Type	BNC								
Configuration	Unbalanced, active								
Maximum Input Level	-20 dBm								
Impedance	50 Ω								
Bias Voltage	12 V DC, 150 mA (300 mA maximum)								
Cascade Output									
Connector Type	BNC								
Configuration	Unbalanced, active								
Impedance	50 Ω								
Insertion Loss	<5 dB								
Monitor Audio Output									
Audio Frequency Response	40 – 18 kHz, ±3 dB								
Configuration	Unbalanced mono, 1/4 in. (will drive stereo phones)								
Impedance	50 Ω								
Maximum Signal Level (45 kHz max. deviation)	1 W @ 63 Ω								
Pin Assignments	Tip: audio + Ring: audio + Sleeve: ground								
Networking									
Power Over Ethernet (PoE)	50 V DC, Class 1								
Network Interface	Dual Port Ethernet 10/100								
Network Addressing Capability	DHCP or Manual IP address								



Updated: 04/19

Component Specifications *(continued)*

Included Components

95N2035	1-foot Coaxial Cascade Cable (2)
95A9128	IEC AC Power Cable (1)
95A9129	IEC AC Extension Cable (1)
C803	Shielded 3-foot Ethernet Cable (1)
C8006	Shielded 8-inch Ethernet Jumper Cable (1)
90XN1371	Hardware Kit (1)
95B9023	22-inch Coaxial Cable* (1)
95C9023	33-inch Coaxial Cable* (1)

* with integrated bulkhead for front mounting antennas.

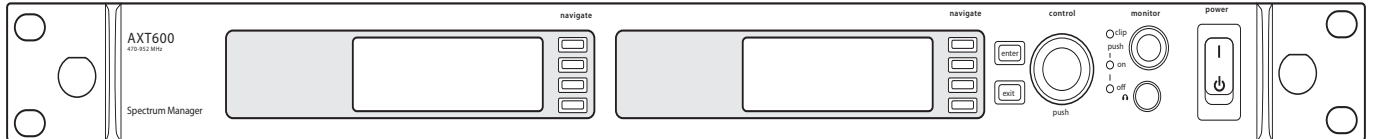

AXT600 Spectrum Manager Front

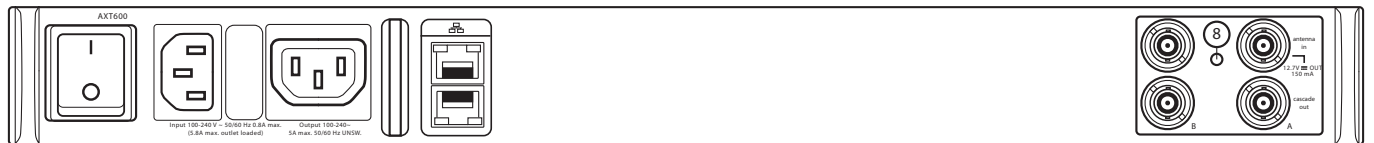

AXT600 Spectrum Manager Back

Component Specifications

AXT630, AXT631 Antenna Distribution Systems

Overview

Antenna Distribution Systems send the RF signal from a single pair of antennas to multiple receivers. Ultra-linear amplification and adjustable attenuation optimize performance in difficult RF environments. Selectable input filters match the available frequency bands of transmitters, providing extra protection from strong out-of-band signals. BNC antenna output pairs distribute band-filtered signal to up to 4 receivers. A pair of wideband cascade ports supplies a wideband RF signal to Spectrum Managers or additional antenna distribution amplifiers. Networking enables Wireless Workbench® 6 system control of filtering ranges and attenuation. To maximize use of available RF spectrum, two models of the Antenna Distribution System are available. The AXT630 covers a frequency range of 470-698 MHz and the AXT631 covers a frequency range of 606-814 MHz.

Features

- Selectable input filtering provides system-wide protection against strong out-of-band signals
- Wideband filtering option covers multiple bands
- Up to 15 dB of selectable RF attenuation for signal-to-noise optimization
- Front panel interface and Wireless Workbench 6 software control provide easy setup and control of filtering, antenna power, and attenuation
- BNC outputs: 4 antenna output pairs
- Wideband RF cascade port with selectable 3 dB make-up gain for connecting wideband devices
- Ethernet Networking: 2 PoE enabled Ethernet ports
- IEC power ports enable daisy-chaining of AC power

Specifications

Dimensions	44 mm x 483 mm x 366 mm (1.7 in. x 19.0 in. x 14.4 in.), H x W x D	
Weight	4.6 kg (10.1 lbs)	
Housing	Steel; Extruded aluminum	
Operating Temperature Range	-18°C (0°F) to 63°C (145°F)	
Storage Temperature Range	-29°C (-20°F) to 74°C (165°F)	
Power Requirements	100 to 240 V AC, 50-60 Hz	
Current Drain	1.0 A RMS (referenced at 120 V AC)	
RF Input		
Connector Type	BNC	
Configuration	Unbalanced, active	
Band Filters	AXT630:	Wideband: 470-698 MHz Band G1: 470-530 MHz Band H4: 518-578 MHz Band J5: 578-638 MHz Band L3: 638-698 MHz
	AXT631:	Wideband: 606-814 MHz Band K4E: 606-666 MHz Band M8: 666-730 MHz Band P8, P9: 710-790 MHz Band Q5: 740-814 MHz
Impedance	50 Ω	
Bias Voltage	12 V DC, 150 mA (300 mA maximum)	
RF Frequency Range	AXT 630: 470-698 MHz AXT 631: 606-814 MHz	
Distribution Output		
Connector Type	BNC (4 pairs)	
Configuration	Unbalanced, active	
Impedance	50 Ω	
Gain Adjustment Range	Cascade Enabled: -15 dB to 0 dB (In 1 dB steps) Cascade Disabled: -12 dB to +3 dB (In 1 dB steps)	
Output Intercept Point	>25 dBm, typical	
Cascade Output		
Connector Type	BNC (1 pair)	
Configuration	Unbalanced, wideband	
Impedance	50 Ω	
Insertion Loss	<5 dB	
Networking		
Power Over Ethernet (PoE)	50 V DC, Class 1	
Network Interface	Dual Port Ethernet 10/100 Mbps	
Network Addressing Capability	DHCP or Manual IP address	



Updated: 04/19

Component Specifications *(continued)*

Included Components

UA802	2-foot Coaxial Antenna Cable (RG-58) (12)
95A9128	IEC AC Power Cable (1)
95A9129	IEC AC Extension Cable (1)
C803	Shielded 3-foot Ethernet Cable (1)
C8006	Shielded 8-inch Ethernet Jumper Cable (1)
90XN1371	Hardware Kit (1)
95B9023	22-inch Coaxial Cable* (1)
95C9023	33-inch Coaxial Cable* (1)

* with integrated bulkhead for front mounting antennas.

Optional Accessories

1/2 Wave Antennas

UA8-518-578	For frequency range 518–578 MHz
UA8-578-638	For frequency range 578–638 MHz
UA8-638-698	For frequency range 638–698 MHz
UA8-572-596	For frequency range 572–596 MHz
UA8-554-590	For frequency range 554–590 MHz
UA8-470-530	For frequency range 470–530 MHz
UA8-500-560	For frequency range 500–560 MHz
UA8-900-1000	For frequency range 900–1000 MHz
UA8-470-542	For frequency range 470–542 MHz
UA8-554-626	For frequency range 554–626 MHz
UA8-626-698	For frequency range 626–698 MHz
UA8-518-598	For frequency range 518–598 MHz

Antennas

UA860SWB	Passive Omnidirectional Antenna (470–1100 MHz)
PA805SWB	Passive Directional Antenna (470–952 MHz)
HA-8089	Helical Antenna (480–900 MHz)
HA-8091	Domed Helical Antenna (460–900 MHz)

In-Line RF Amplifiers

UA834WB	In-Line Antenna Amplifier (470–902 MHz)
UA834XA	In-Line Antenna Amplifier (902–960 MHz)

Active Directional Antennas

UA874US	Active Directional Antenna (470–698 MHz)
UA874E	Active Directional Antenna (470–790 MHz)
UA874WB	Active Directional Antenna (470–900 MHz)
UA874X	Active Directional Antenna (925–952 MHz)
UA874XA	Active Directional Antenna (902–960 MHz)
UA864HI	Wall-Mounted Active Directional Antenna (530–790 MHz)
UA864A	Wall-Mounted Active Directional Antenna (650–952 MHz)

Cables

UA825	25-foot Coaxial Cable RG8/X
UA850	50-foot Coaxial Cable RG8/X
UA8100	100-foot (30.4 m) Antenna Extension Cable

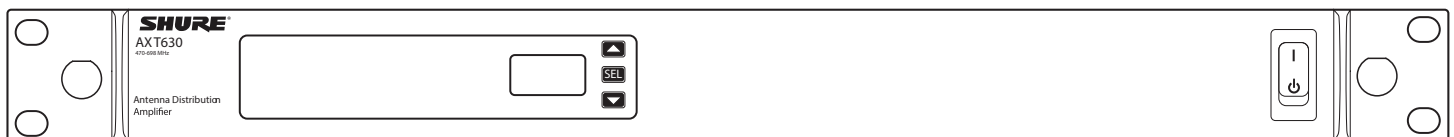

AXT630 Antenna Distribution System Front

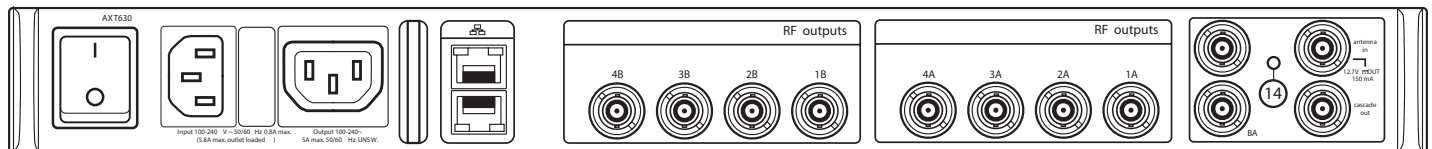

AXT630 Antenna Distribution System Back



Updated: 04/19

www.shure.com

Whilst every effort has been made to ensure that the information in this document is correct, we accept no liability in respect of errors or omissions. All specifications within this document are subject to change without notice.

© 2019 Shure Incorporated

Component Specifications

AD610 Showlink® Wireless Access Point

Overview

The AD610 ShowLink® access point enables real-time remote control of all ShowLink-enabled Axient® transmitters, including both ADX and AXT series models. The access point allows comprehensive management of transmitter parameters from the receiver or Wireless Workbench® using 2.4 GHz (IEEE 802.15.4) wireless communication. All parameter changes occur without interruption to the performer.

Features

- Wireless network connectivity between all linked transmitters and access points
- Enables real-time wireless remote control of up to 24 transmitters per access point
- ShowLink offers ability to adjust gain, change frequencies, mute signals and more
- True Diversity antenna scheme maintains a robust link in the 2.4 GHz frequency range
- Automatic channel selection scans the 2.4 GHz range for the best channel. Scans can be saved for future analysis in Wireless Workbench
- Automatic frequency agility moves the network to the best available channel if signal degrades
- Is compatible with Axient Digital ADX series and Axient analog (AXT series) systems.

Specifications

Antenna Type	2 Omnidirectional 2.4 GHz
Capacity	24 Axient transmitters
Mounting Type	WA371 Mic Clip or 1/4-20 thread mount
Operating Temperature Range	-18 °C (0 °F) to 63 °C (145 °F)
Storage Temperature Range	-29 °C (-20 °F) to 74 °C (165 °F)
Dimensions	190 mm x 102 mm x 47 mm (7.34 in. x 3.960 in. x 1.825 in.) H x W x D, without antenna
Weight	464 g (16.3 oz.), without antenna
Housing	Extruded Aluminum
Power Requirements	Power over Ethernet (PoE) Class 1: 36 to 57 VDC/VAC External Power Supply (if PoE is unavailable): 15 V DC (600 mA), double insulated
ShowLink	
Network Type	IEEE 802.15.4
Frequency Range	2.40 to 2.4835 GHz (16 Channels)
RF Output Power	10 dBm (ERP) / 20 dBm (ERP) <i>Dependent on applicable country regulations</i>
Working Range	Under typical conditions: 150 m (500 ft) Line of Sight, outdoors for a single system: 500 m (1600 ft) Note: Actual range depends on RF signal absorption, reflection and interference.
Antenna Connection	
Connector	2 SMA (Shell=Ground, Center=Signal)
Impedance	50 Ω
Scanning Radio	
Scanner RF Sensitivity	-106 dBm, typical (integrated antenna)
Networking	
Network Interface	Ethernet 10/100
Network Addressing Capability	DHCP or Manual IP address (configurable using Wireless Workbench)

Available Models

AD610	Showlink Wireless Access Point
-------	--------------------------------

Furnished Accessories

WA371	Wireless microphone clip for mounting on a microphone stand	C825	Shielded 25-foot Ethernet cable for ShowLink access point, RJ45-to-EtherCon connector
31A1856	Euro thread adapter for WA371	PS43	Power Supply (regionally dependent)

Optional Accessories

AXT644	Directional 2.4 GHz Patch Antenna
---------------	-----------------------------------

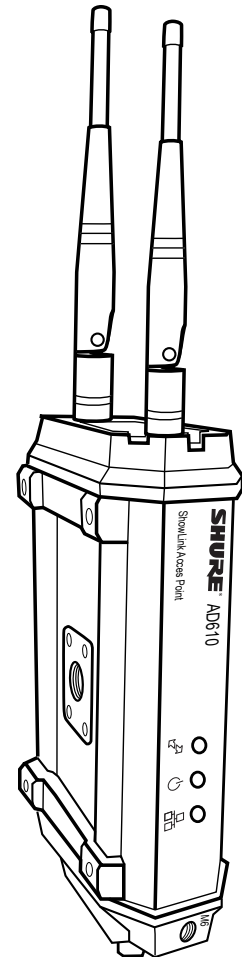

AD610 ShowLink® Wireless Access Point

SHURE®

www.shure.com

Updated: 04/19

Whilst every effort has been made to ensure that the information in this document is correct, we accept no liability in respect of errors or omissions. All specifications within this document are subject to change without notice.

© 2019 Shure Incorporated

Component Specifications

SBC840 Eight-Bay Networked Charger

Overview

The SBC840 networked charger provides a compact charging and storage solution for any combination of up to 8 SB910 or SB920 batteries. The charger is network-enabled to allow for remote monitoring of charger and battery parameters using Shure Wireless Workbench software.

Features

- Charging for any combination of up to 8 SB910 or SB920 batteries
- Compact design fits inside 1RU drawers
- LEDs indicate charge status and errors
- Storage mode to prepare batteries for long-term storage
- Network-enabled for remote monitoring

Specifications

Battery Type	Up to 8 SB910/SB920
Charge Current	1.25 A maximum
Charge Time	1 hour: 50% 3 hours: 100%
External Power Supply	PS60
Power Requirements	0 °C (32 °F) to 60 °C (140 °F)
Housing	Molded ABS
Dimensions	35 mm x 397 mm x 137 mm (1.4 in. x 15.6 in. x 5.40 in.) L x W x D
Weight	0.91 kg (2 lb), Without Batteries
Operating Temperature Range <i>Note: Battery characteristics may limit this range</i>	-18 °C (0 °F) to 50 °C (122 °F)
Storage Temperature Range <i>Note: Battery characteristics may limit this range</i>	-29 °C (-20 °F) to 74 °C (165°F)
Networking	
Network Interface	10/100 Mbps Ethernet
Network Addressing Capability	DHCP or Manual IP address

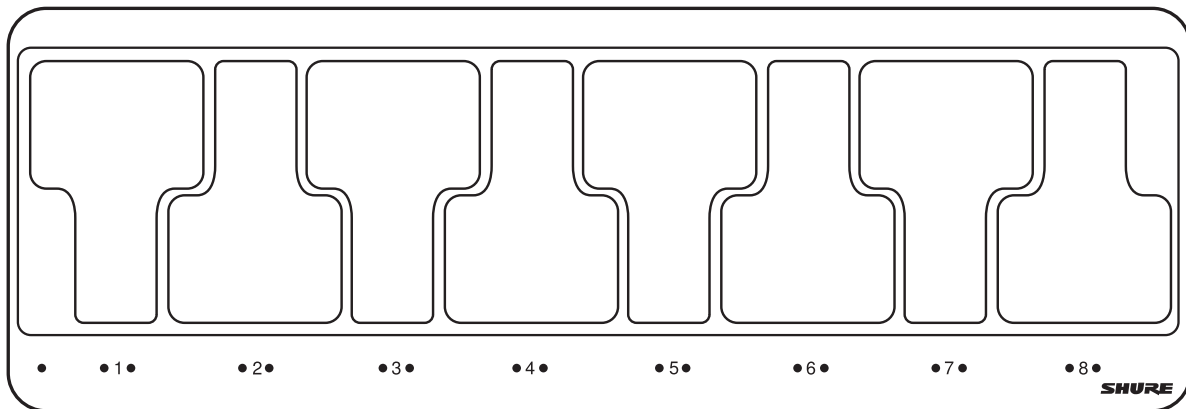

SBC840 8-bay Networked Charger

SHURE[®]

www.shure.com

Updated: 04/19

Whilst every effort has been made to ensure that the information in this document is correct, we accept no liability in respect of errors or omissions. All specifications within this document are subject to change without notice.

© 2019 Shure Incorporated

Component Specifications

SBC840M Eight-Bay Networked Charger

Overview

The SBC840M networked charger provides a compact charging and storage solution for up to 8 SB910M. The charger is network-enabled to allow for remote monitoring of charger and battery parameters using Shure Wireless Workbench software.

Features

- Charging for up to 8 SB910M batteries
- LEDs indicate charge status and errors
- Storage mode to prepare batteries for long-term storage
- Network-enabled for remote monitoring

Specifications

Battery Type	Up to 8 SB910M
Charge Current	5.75 A maximum
Charge Time	1 hour: 50% 3 hours: 100%
External Power Supply	PS60
Power Requirements	15 V, 3.33 A maximum
Housing	Molded ABS
Dimensions	52 × 88 × 250 mm (2.0 × 3.5 × 9.9 in) H × W × D
Weight	425 g (1 lb) Without Batteries
Operating Temperature Range <i>Note: Battery characteristics may limit this range</i>	-18 °C (0 °F) to 50 °C (122 °F)
Storage Temperature Range <i>Note: Battery characteristics may limit this range</i>	-29 °C (-20 °F) to 74 °C (165 °F)

Networking

Network Interface	10/100 Mbps Ethernet
Network Addressing Capability	DHCP or Manual IP address

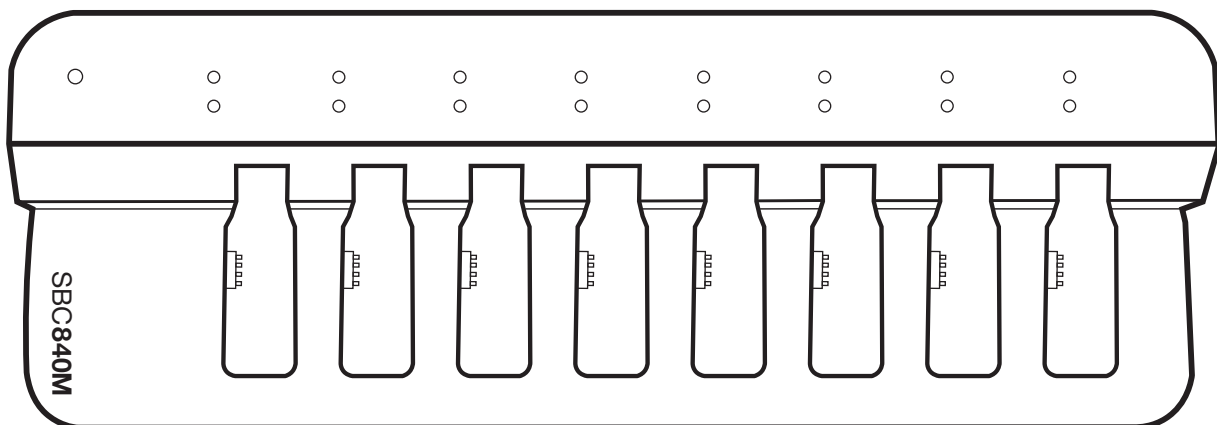

SBC840M 8-bay Networked Charger

SHURE[®]

www.shure.com

Updated: 04/19

Whilst every effort has been made to ensure that the information in this document is correct, we accept no liability in respect of errors or omissions. All specifications within this document are subject to change without notice.

© 2019 Shure Incorporated

Component Specifications

SBC240 Two-Bay Networked Charger

Overview

The SBC240 networked docking charger provides a compact charging and storage solution for any combination of 2 SB910/SB920 batteries or ADX1, ADX2, or ADX2FD transmitters using Shure rechargeable batteries. The charger is network-enabled to allow for remote monitoring of charger and battery parameters using Shure Wireless Workbench software. Connect up to 4 SBC240 chargers together to share power and network connectivity.

Features

- Charging for any combination of up to 2 SB910/SB920 batteries or ADX1, ADX2, or ADX2FD transmitters using Shure rechargeable batteries
- Connect up to 4 chargers together to share power and network connections and save space
- LEDs indicate charge status and errors
- Storage mode to prepare batteries for long-term storage
- Network-enabled for remote monitoring

Specifications

Battery Type	Up to 2 SB910/SB920
Compatible Transmitters	Up to 2 SB910/SB920
Charge Current	1.25 A maximum
Charge Time	1 hour: 50% 3 hours: 100%
External Power Supply	PS60
Power Requirements	15 V, 3.33 A maximum
Housing	Molded ABS
Dimensions	65.25 mm × 88.74 mm × 210.82 mm (2.57 in. × 3.49 in. × 8.30 in.) L × W × D
Weight	0.45 kg (1 lb), Without Batteries
Operating Temperature Range <i>Note: Battery characteristics may limit this range</i>	-18 °C (0 °F) to 50 °C (122 °F)
Storage Temperature Range <i>Note: Battery characteristics may limit this range</i>	-29 °C (-20 °F) to 74 °C (165°F)
Networking	
Network Interface	10/100 Mbps Ethernet
Network Addressing Capability	DHCP or Manual IP address

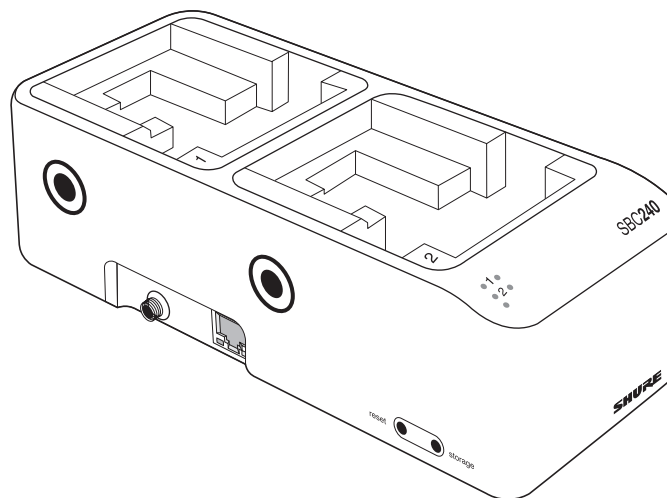

SBC240 2-Bay Networked Charger

SHURE[®]

www.shure.com

Updated: 04/19

Whilst every effort has been made to ensure that the information in this document is correct, we accept no liability in respect of errors or omissions. All specifications within this document are subject to change without notice.

© 2019 Shure Incorporated

Component Specifications

SBRC Battery Rack Charger

Overview

The Shure Battery Rack Charger (SBRC) provides a seamless, touring-ready battery charging and storage solution. Interchangeable charging modules support a variety of Shure Lithium-ion batteries, accommodating up to eight batteries in a single rack space. An easy-to-read, front-panel LCD screen displays critical parameters including charge levels, time-to-full, and battery health indicators such as temperature and cycle count. When connected to a network, Shure Wireless Workbench® and ShurePlus Channels software provide remote monitoring of battery status.

Features

- Comprehensive status display with straightforward three-button interface control
- Easily visible charge status by percentage and time-to-full readings in hours and minutes
- Battery health tracking metrics indicate percentage of original capacity and cycle count
- Remote monitoring of battery status through Shure Wireless Workbench® software
- Interchangeable charging modules allow users to mix and match up to eight Shure bodypack and handheld transmitter batteries
- Charges batteries to 50 percent capacity within one hour and full capacity within three hours
- Storage mode prepares batteries for optimal long-term storage
- Charges Shure SB900A, AXT910, and AXT920 rechargeable batteries

Specifications

Battery Type	Up to 8 rechargeable Li-Ion batteries
Charge Time	50%=1 hour; 100%=3 hours
Charging Module Type	Up to 4 charging modules in any combination
Operating Temperature Range	-18 °C (0 °F) to 63 °C (145 °F)
Battery Charging Temperature Range	0 °C (32 °F) to 60 °C (140 °F)
Storage Temperature Range	-29 °C (-20 °F) to 74 °C (165 °F)
Dimensions	44 mm × 483 mm × 366 mm (1.7 in. × 19.0 in. × 14.4 in.), H × W × D
Weight	4.4 kg (9.8 lbs), without batteries or charging modules
Housing	Steel; Extruded aluminum
Power Requirements	100 to 240 V AC, 50-60 Hz
Current Drain	1.8 A RMS (referenced at 90 V AC)
Networking	
Network Interface	Ethernet 10/100 Mbps
Network Addressing Capability	DHCP or Manual IP address

Furnished Accessories

(Region Dependent)	IEC AC Power Cable (1)	90XN1371	Hardware Kit (1)
C803	Shielded 3-foot Ethernet Cable (1)	30B13476	Mounting Screws for Charger Modules (8)

Optional Accessories

SBC-AX	Charging Module for SB900A	SBM920	Charging Module for SB920
SBM910	Charging Module for SB910		
SBM910M	Charging Module for SB910M		

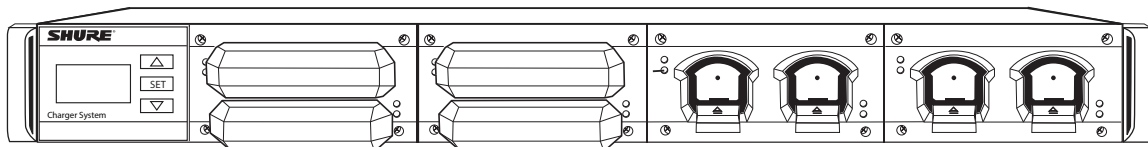

SBRC Rack Charger Front

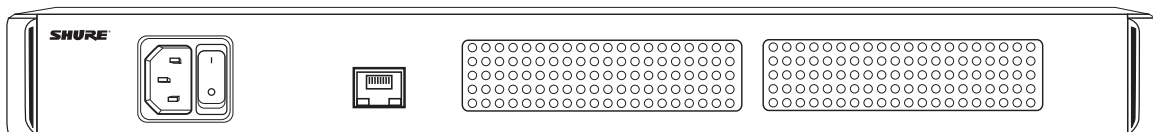

SBRC Rack Charger Back



Updated: 04/19

www.shure.com

Whilst every effort has been made to ensure that the information in this document is correct, we accept no liability in respect of errors or omissions. All specifications within this document are subject to change without notice.

© 2019 Shure Incorporated

Component Specifications

SB900A Lithium-Ion Rechargeable Battery

Specifications

Nominal Capacity	1450 mAh
Nominal Voltage	3.7 V
Dimensions	7 mm × 34 mm × 50 mm (.28 in. × 1.34 in. × 1.97 in.), H × W × D
Weight	40 g (1.41 oz.)
Housing	Engineered Thermoplastic Resin
Charging Temperature Range	0 °C (32 °F) to 45 °C (113 °F)
Discharging Temperature Range	-18 °C (0 °F) to 60 °C (140 °F)
Recommended Storage Temperature Range	10 °C (50 °F) to 25 °C (77 °F)

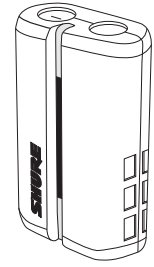

SB900A
Rechargeable
Lithium-Ion Battery

SB910 Lithium-Ion Rechargeable Battery

Specifications

Nominal Capacity	2200 mAh
Nominal Voltage	3.6 V
Dimensions	13.9 mm × 39.4 mm × 53.3 mm (.54 in. × 1.55 in. × 2.10 in.), H × W × D
Weight	48 g (1.69 oz.)
Housing	Engineered Thermoplastic Resin
Charging Temperature Range	0 °C (32 °F) to 60 °C (140 °F)
Discharging Temperature Range	-18 °C (0 °F) to 60 °C (140 °F)
Recommended Storage Temperature Range	10 °C (50 °F) to 25 °C (77 °F)

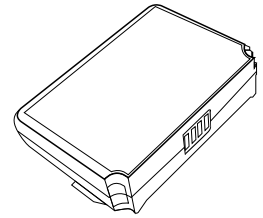

SB910
Rechargeable
Lithium-Ion Battery

SB910M Lithium-Ion Rechargeable Battery

Specifications

Nominal Capacity	1150 mAh
Nominal Voltage	3.7 V
Dimensions	8.8 mm × 38.8 mm × 54.1 mm (.35 in. × 1.53 in. × 2.13 in.), H × W × D
Weight	31 g (1.09 oz.)
Housing	Engineered Thermoplastic Resin
Charging Temperature Range	0 °C (32 °F) to 60 °C (140 °F)
Discharging Temperature Range	-18 °C (0 °F) to 60 °C (140 °F)
Recommended Storage Temperature Range	10 °C (50 °F) to 25 °C (77 °F)

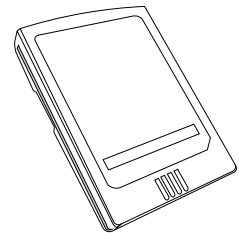

SB910M
Rechargeable
Lithium-Ion Battery

SB920 Lithium-Ion Rechargeable Battery

Specifications

Nominal Capacity	2500 mAh
Nominal Voltage	3.6 V
Dimensions	20.8 mm × 23.7 mm × 72.8 mm (.83 in. × .93 in. × 2.87 in.), H × W × D
Weight	54 g (1.90 oz.)
Housing	Engineered Thermoplastic Resin
Charging Temperature Range	0 °C (32 °F) to 60 °C (140 °F)
Discharging Temperature Range	-18 °C (0 °F) to 60 °C (140 °F)
Recommended Storage Temperature Range	10 °C (50 °F) to 25 °C (77 °F)

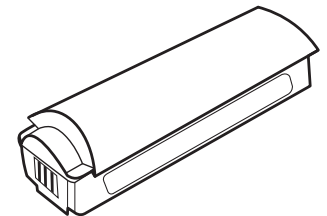

SB920
Rechargeable
Lithium-Ion Battery

